

**1597DINCOV1**

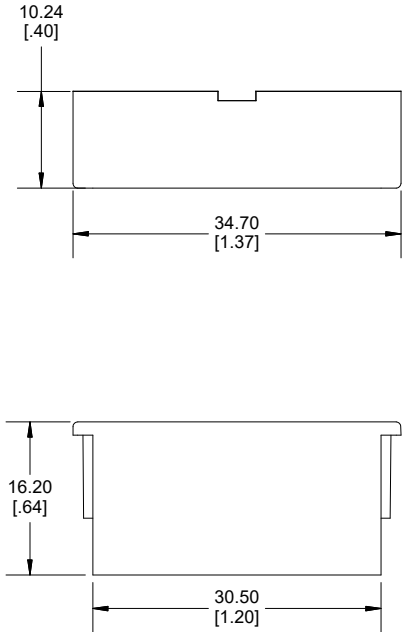

**1597DINCOV2**

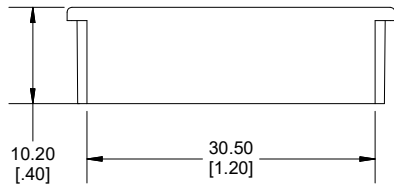
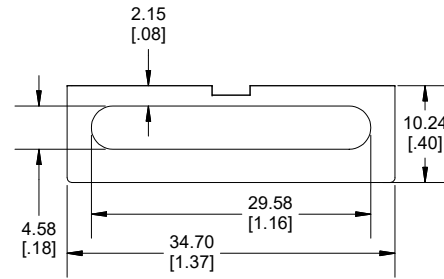

**1597DINCOV3**

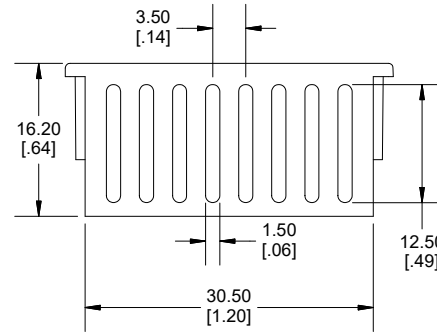
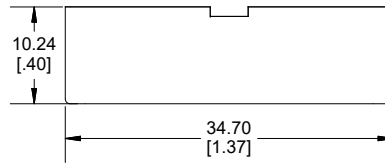

**1597DINCOV4**

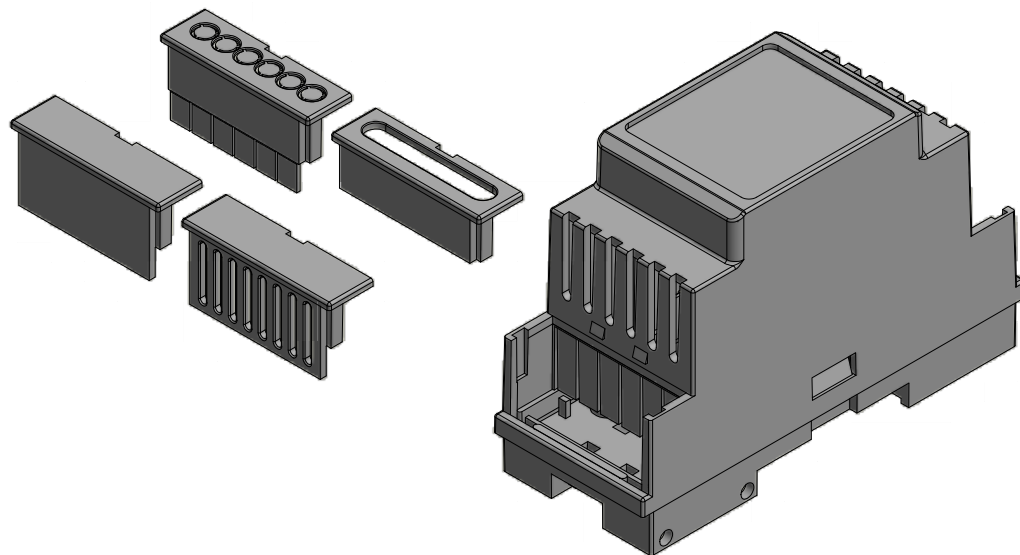
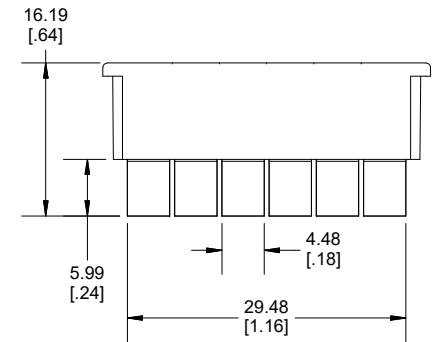
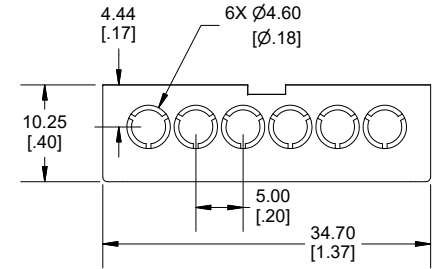

Dimensions:  
mm  
[inches]

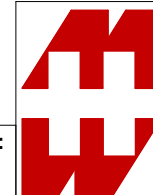

**HAMMOND  
MANUFACTURING®  
1597DIN ACCS**

[www.hammondmfg.com](http://www.hammondmfg.com)