

Buccaneer 6000 Series Waterproof Connector

For Data - Ethernet

Wiring and Assembly instructions



Before using the connector, it is important that these instructions are carefully read and understood to ensure the connector system is completely water tight and performs to specification.

Cable Glands

To ensure the correct cable sealing, cable glands are supplied to accurately fit cable diameters from 4.0 to 8.0mm. It is important to choose the closest gland size to the cable being used.

Cable diameter	Gland Colour
4.0 - 5.0mm	Dark Grey
5.0 - 7.0mm	White



bulgin

a brand of Elektron Technology

www.elektron-bulgin.com

1

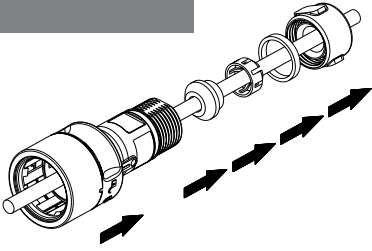

2

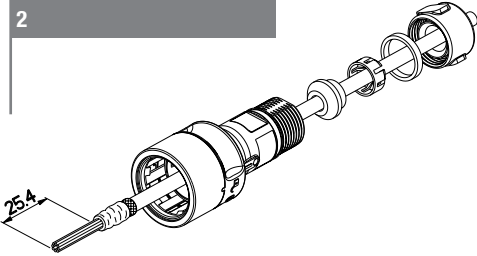

3

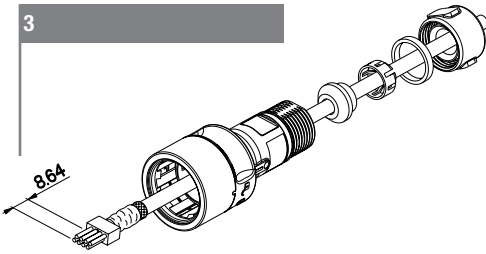

4

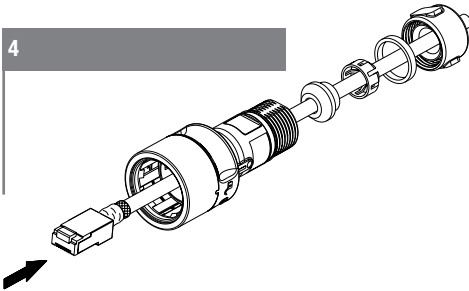

WARNING – PXP & PXM6034 **

Ensure 'o' ring is seated in flex connector

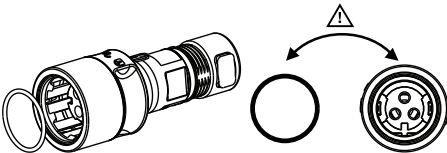

5

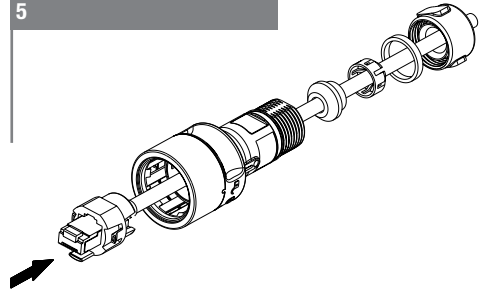

6

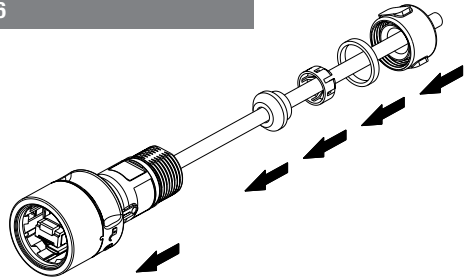

7

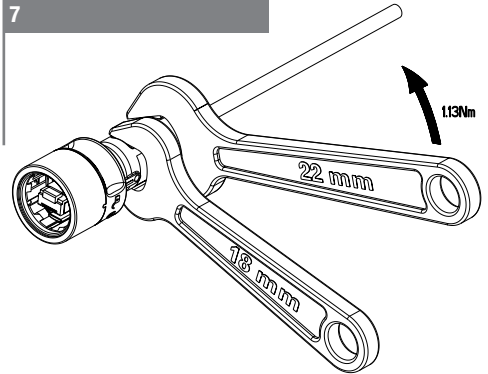

14917/SP

Contact carrier removal

