

TACT SWITCH DTS(G)MW-6 SERIES

6x6 Gull-Wing SMT
Washable Type IP67

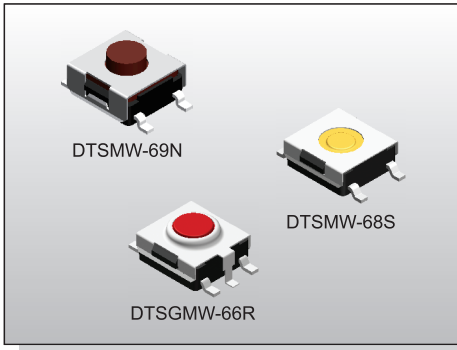

FEATURES

- ✘ Sealed IP67
- ✘ Reflow solderable
- ✘ Dust proof with high reliability

APPLICATION

- ✘ Audio, OA equipment
- ✘ Instrumentation, Communication
- ✘ White goods

SPECIFICATION

Contact Rating	50mA, 12V DC
Contact Resistance	100mΩ max.
Insulation Resistance	100MΩ min. 500V DC
Dielectric Strength	250V AC/1 minute
Operating Force	160±50gf, Brown(N) 66/677 160±50gf, Silver(S) 68 180±50gf, Brown(N) 69/67/65/64 260±70gf, Red(R) 69/67/66/65/64 360±90gf, Transparent(T) 69/67/65/677
Travel	0.25mm 68S/66N/66R/677 0.45mm (69/67N,R)(65/64N,R,T) 0.6mm 69/67T
Operating Life	100,000 cycles min. for 68/66/677 500,000 cycles min. for 69/67/65/64
Operating Temp.	-25°C ~ +70°C
Storage Temp.	-30°C ~ +80°C

HOW TO ORDER

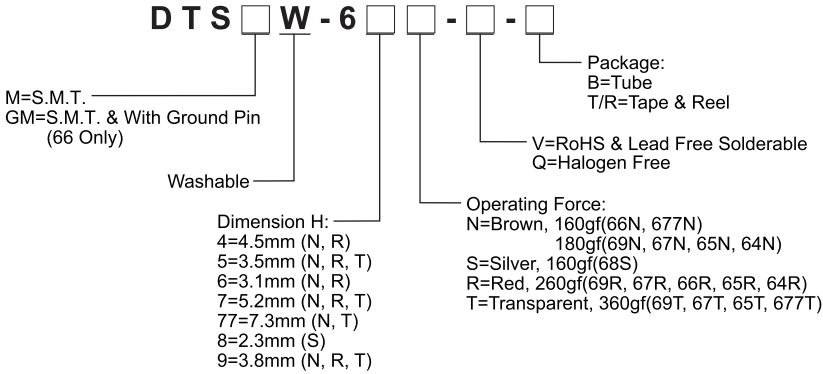

CIRCUIT

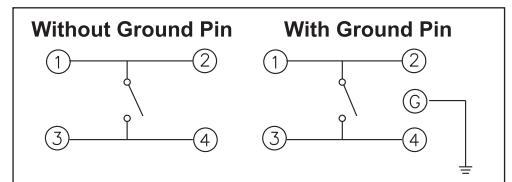

PACKAGE

<Tube>

75 pcs

<Tape & Reel>

DTSGMW-66: 2000 pcs

DTSMW-68, 66: 2000 pcs

DTSMW-69, 65: 1900 pcs

DTSMW-67, 64: 900 pcs

DTSMW-677: 650 pcs

DTSGMW-66

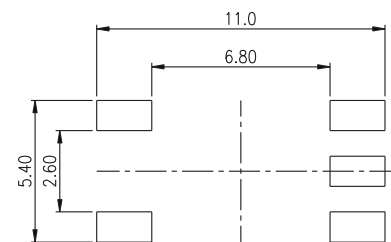
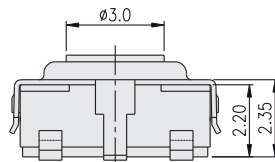
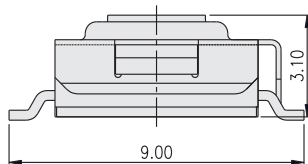
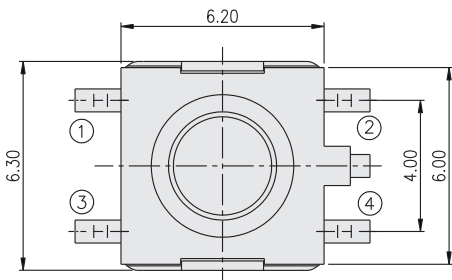

P.C.B. LAYOUT

DTSMW-68

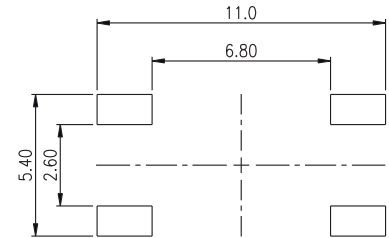
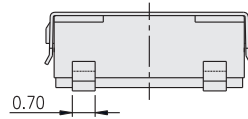
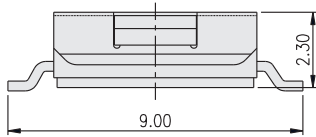
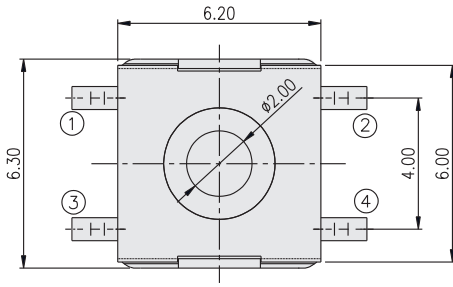

P.C.B. LAYOUT

TACT SWITCH

DTSMW-6 □

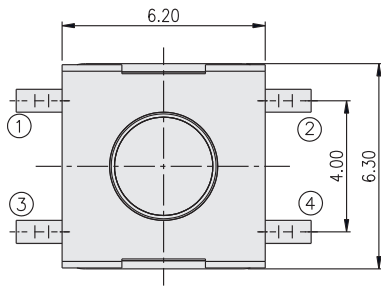

PART NO.	H
DTSMW-64	4.50
DTSMW-65	3.50
DTSMW-67	5.20
DTSMW-69	3.80
DTSMW-677	7.30

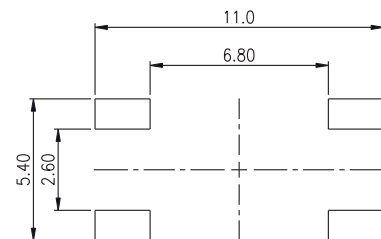
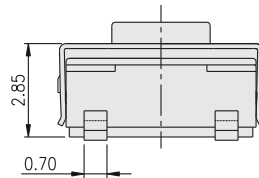
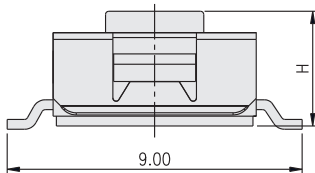

P.C.B. LAYOUT