

TACT SWITCH
DTSYHL-6 SERIES

**6x6 Through Hole Type
(Pitch 4.0mm)**

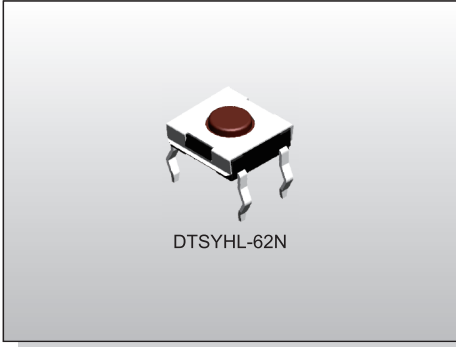

FEATURES

- ✘ Low profile with 2.5-3.5mm height
- ✘ Snap-in type
- ✘ Sharp click feeling

APPLICATION

- ✘ Audio, OA equipment
- ✘ Instrumentation
- ✘ Industrial

SPECIFICATION

Contact Rating	50mA, 12V DC
Contact Resistance	100mΩ max.
Insulation Resistance	100MΩ min. 500V DC
Dielectric Strength	250V AC/1 minute
Operating Force	100±50gf, Black(K) 160±50gf, Brown(N) 260±50gf, Red(R)
Travel	0.25mm
Operating Life	100,000 cycles for 260gf 1,000,000 cycles for 160, 100gf
Operating Temp.	-25°C ~ +70°C
Storage Temp.	-40°C ~ +70°C

HOW TO ORDER

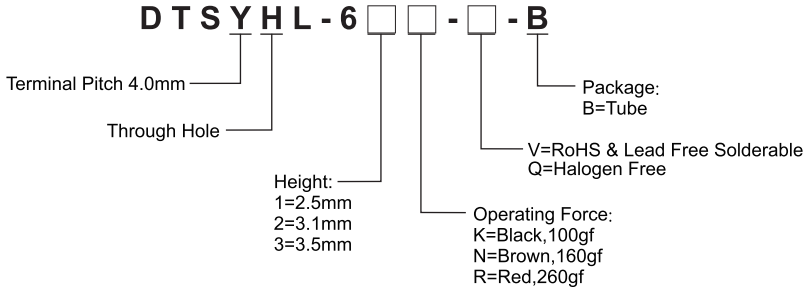

CIRCUIT

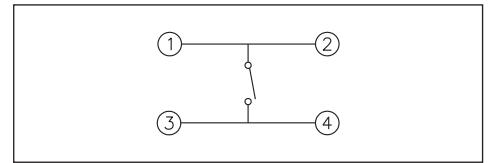

PACKAGE

<Tube>
75 pcs

TACT SWITCH

DTSYHL-6

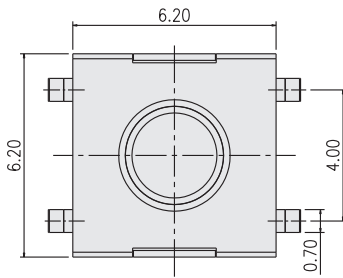

PART NO.	H
DTSYHL-61	2.50
DTSYHL-62	3.10
DTSYHL-63	3.50

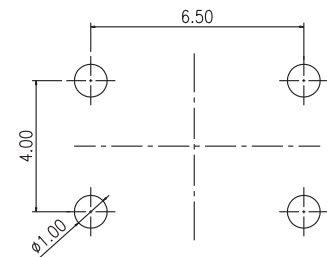
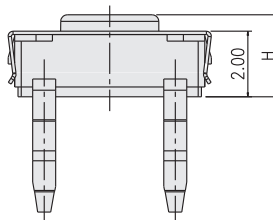
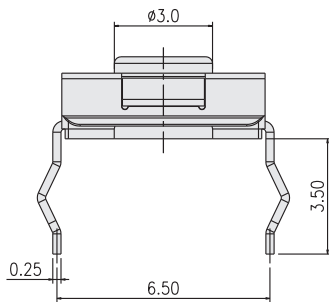

P.C.B. LAYOUT