

**FEATURES**

- ✘ Compact-sized 2.9x3.9mm
- ✘ Vertical or side actuation
- ✘ Reflow solderable

**APPLICATION**

- ✘ Automotive
- ✘ Portable electronic device
- ✘ Control panel

**SPECIFICATION**

Contact Rating	50mA, 12V DC
Contact Resistance	100mΩ max.
Insulation Resistance	100MΩ min. 100V DC
Dielectric Strength	100V AC/1 minute
Operating Force	160±50gf (Vertical Push) 220±65gf (Side Push)
Travel	0.13mm (Vertical Push) 0.20mm (Side Push)
Operating Life	100,000 cycles
Operating Temp.	-20°C ~ +70°C
Storage Temp.	-30°C ~ +80°C

**HOW TO ORDER**

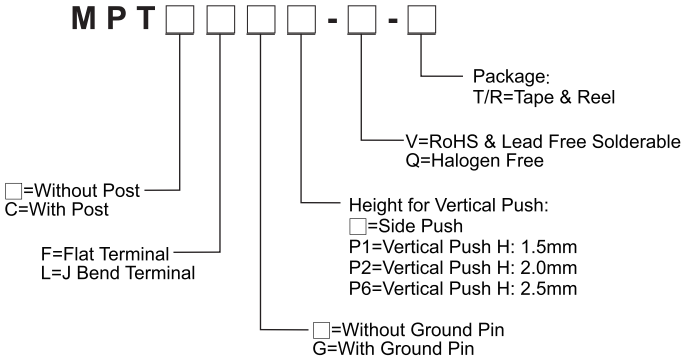

**CIRCUIT**

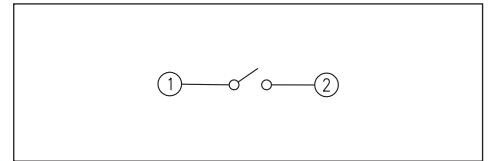

**PACKAGE**

<Tape & Reel>  
Side push type: 3500 pcs  
Vertical push type: 2000 pcs

TACT SWITCH

**MPTFP** [ ]

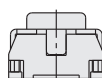
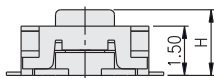
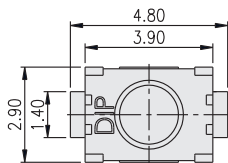

PART NO.	H
MPTFP1	1.50
MPTFP2	2.00
MPTFP6	2.50

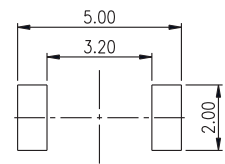

P.C.B. LAYOUT

**MPTCLG**

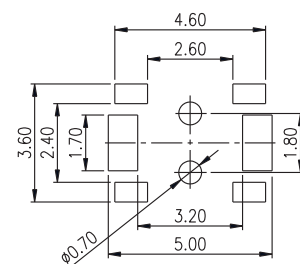
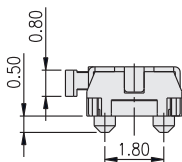
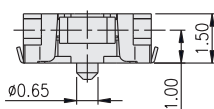
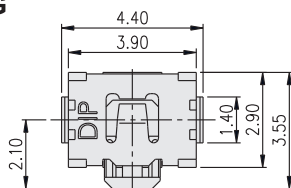

P.C.B. LAYOUT