

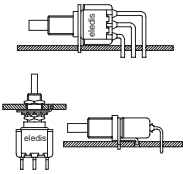

## SERIES 5A

- Snap acting pushbutton



## AGENCY APPROVALS

File N° E195524  
 File N° E195524

## CHARACTERISTICS

- The most comprehensive range of terminations, brackets and bushings.
- Dially phthalate case and stainless steel housing.

## SPECIFICATIONS

**Contact Rating:** **S** (silver) - 1A @ 120 VAC or 28 VDC  
**A** (gold) - 0.4 VA max @ 20 VAC or DC max - **G** (gold on silver) - 1A @ 120 VAC or 0.4 VA max (not both)

**Electrical life:** 50,000 make-and-break cycles at full load

**Contact Resistance:** 10 mΩ max. initial @ 2-4 VDC

**Insulation Resistance:** 1000 MΩ min.

**Dielectric Strength:** 1500 VRMS @ sea level

**Operating Temperature:** -30°C to 85°C

## MATERIALS

**Case:** Dially phthalate (DAP), (UL 94-0)

**Plunger:** Glass filled nylon or glass filled polyester

**Bushing:** Brass, nickel plated

**Housing:** Stainless Steel

**End contacts & terminals:** Copper alloy, with gold plated over nickel plated

**Center Contact & Terminal:** Copper alloy, with gold plated over nickel plated

## HOW TO ORDER



### N° OF POLES

- 1 SPDT
- 2 DPDT

### ELECTRICAL FUNCTIONS

- 1 on (on)

### ACTUATORS

- none
- SF Snap-in + frame + cap
- SN Snap-in + cap
- SG Snap-in + frame (flush)
- JX Snap-in w/o cap & frame
- SL (∅) Snap-in + cap + frame + Led Holder
- SM (∅) Snap-in + cap + frame + Led Holder (flush)

### TERMINATIONS

- PC PCB
- W1 Wire wrap 19.05 mm
- W2 Wire wrap 24.48 mm
- W3 Wire wrap 10.80 mm
- W4 Wire wrap 26.97 mm
- ST Solder tag
- H9 90° horizontal
- V9 90° vertical
- U2 U bracket 11.68 mm
- U3 U bracket 16.00 mm
- U4 U bracket 11.68 mm
- U5 U bracket 16.00 mm
- U2S U bracket snap-in 11.68 mm
- U3S U bracket snap-in 16.00 mm
- U4S U bracket snap-in 11.68 mm
- U5S U bracket snap-in 16.00 mm
- U6(∅) U bracket 11.68 mm
- U7(∅) U bracket 16.00 mm
- U8(∅) U bracket 11.68 mm
- U9(∅) U bracket 16.00 mm
- QC Quick connect

### CAP - FRAME COLOURS OPTIONS

- 1 White
- 2 Black (std)
- 3 Red
- 4(Δ) Orange
- 5(Δ) Yellow
- 6(Δ) Green
- 7(Δ) Blue
- 8(Δ) Brown
- 9(Δ) Gray

### BUSHING

- F1 Threaded
- F2 Unthreaded
- F3 Threaded flat
- F4 Unthreaded flat
- F6(∅) Short Unthreaded

### CONTACT MATERIAL

- S Silver (std)
- A Gold
- G Gold on silver
- K Tinned gold

### CAP OPTIONS

- C1 Diam. 7.7mm
- C2 Diam. 9.35mm
- C5 Sq. 11.7mm
- C7 Diam. 5mm
- C8 Diam. 5mm

### SEALING

- E Seal

Note: No bushing required for Snap-in Actuators  
 (∅) Please Enquire  
 (Δ) Min qty required

## SERIES 5A

### ELECTRICAL FUNCTIONS

### DIMENSIONS

SPDT	Type
<b>1</b>	<b>on (on)</b>
<b>1 - 3</b>	<b>1 - 2</b>

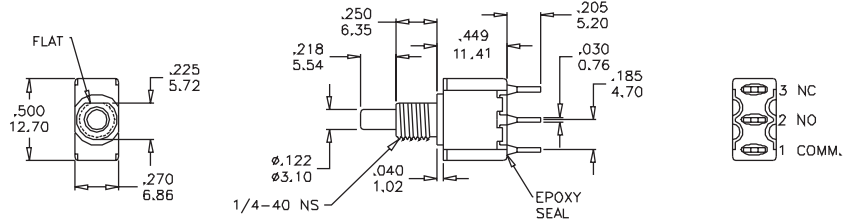

Part N° shown: 5A11-F3PCSE

DPDT	Type
<b>1</b>	<b>on (on)</b>
<b>1-3, 4-6</b>	<b>1-2,4-5</b>

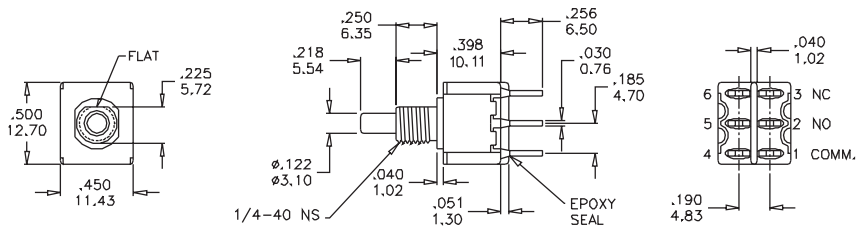
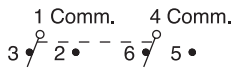

Part N° shown: 5A21-F3TSE

### ACTUATORS

#### SN

Snap-in mounting w/o frame

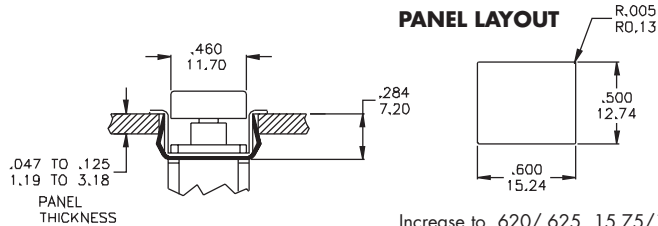

Increase to .620/.625 15.75/15.88 for .091/.125 2.31/3.18 THK PANEL

#### SF

Snap-in mounting extruding cap

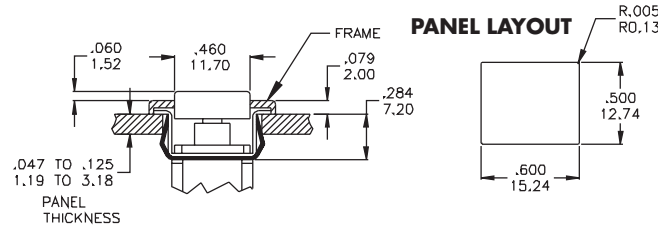
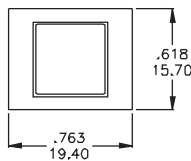

Increase to .620/.625 15.75/15.88 for .091/.125 2.31/3.18 THK PANEL

#### SG

Snap-in mounting flush cap

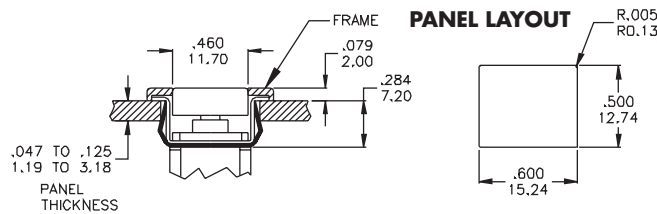
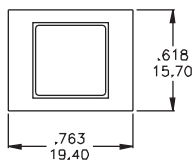

Increase to .620/.625 15.75/15.88 for .091/.125 2.31/3.18 THK PANEL

#### JX

Snap-in mounting no frame, no cap

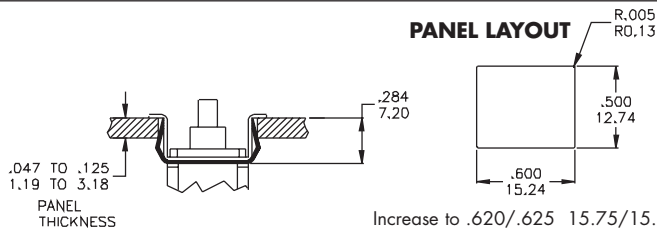

Increase to .620/.625 15.75/15.88 for .091/.125 2.31/3.18 THK PANEL

**CAP + FRAME COLOURS OPTIONS**

- 1 White
- 2 Black (std)
- 3 Red
- 4 (Δ) Orange
- 5 (Δ) Yellow
- 6 (Δ) Green
- 7 (Δ) Blue
- 8 (Δ) Brown
- 9 (Δ) Gray



## SERIES 5A

### ACTUATORS

(◇)SL

Snap-in mounting extruding cap + LED holder

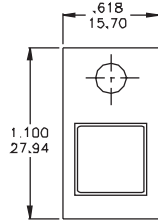

(◇) Please Enquire

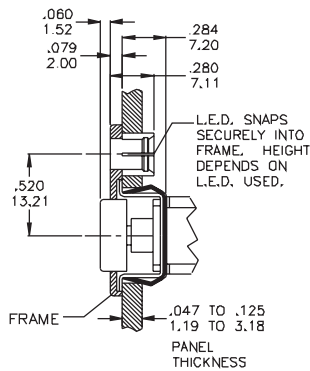

### PANEL LAYOUT

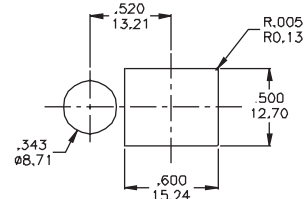

### CAP + FRAME COLOURS OPTIONS

- 1 White
- 2 Black (std)
- 3 Red
- 4 (Δ) Orange
- 5 (Δ) Yellow
- 6 (Δ) Green
- 7 (Δ) Blue
- 8 (Δ) Brown
- 9 (Δ) Gray

**Note:** To order Cap and Frame separately, use C5 and B5 accessories only.

(◇)SM

Snap-in mounting flush cap + LED holder

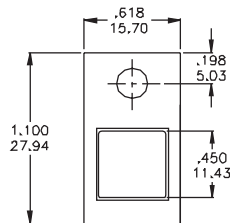

(◇) Please Enquire

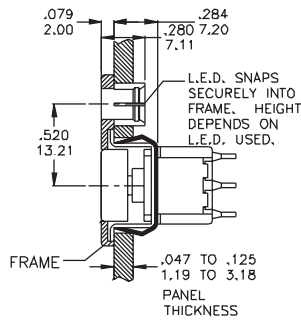

### BUSHING

F1 Threaded (std)

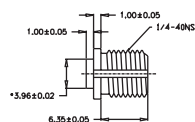
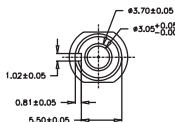

F3 Threaded

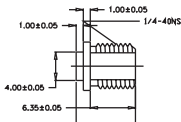
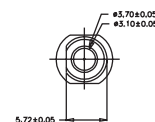

F2 Unthreaded

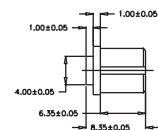
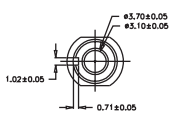

F4 Unthreaded

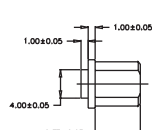
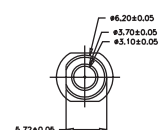

### TERMINATIONS

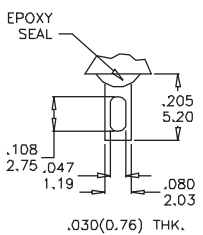

ST

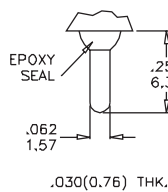

PC

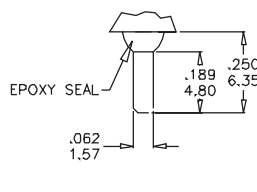

QC

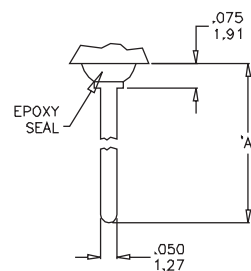

	Dim. A
W1	.750 (19.05)
W2	.964 (24.48)
W3	.425 (10.80)
W4	1.062 (26.97)

Epoxy seal standard with all models

## SERIES 5A

### TERMINATIONS

**H9  
SPDT**

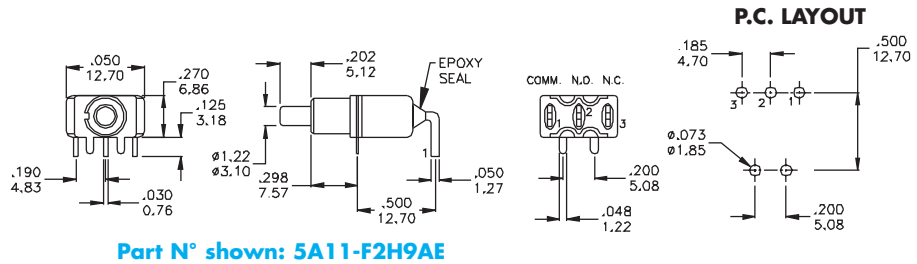

**H9  
DPDT**

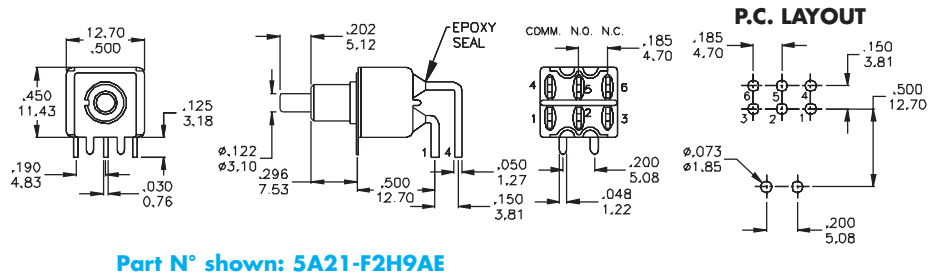

**V9  
SPDT**

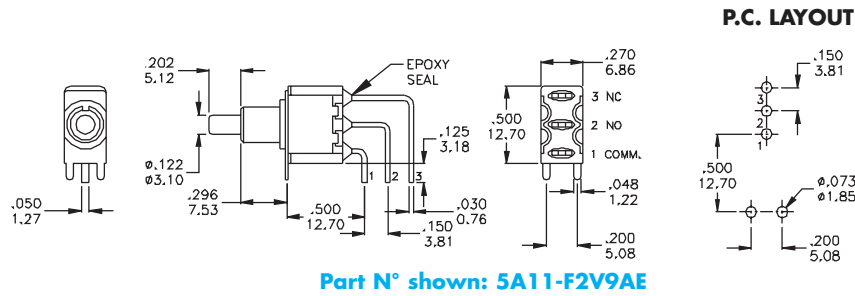

**V9  
DPDT**

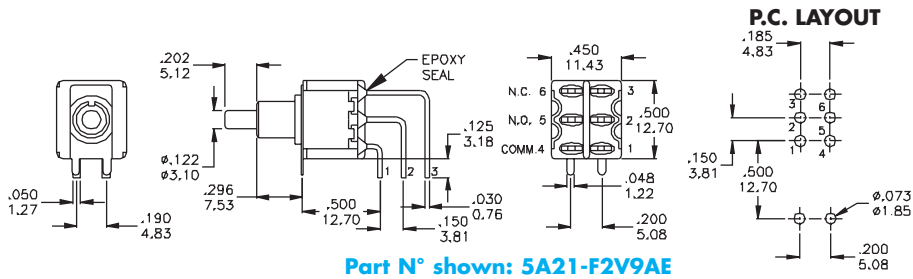

**U2 - U3  
SPDT**

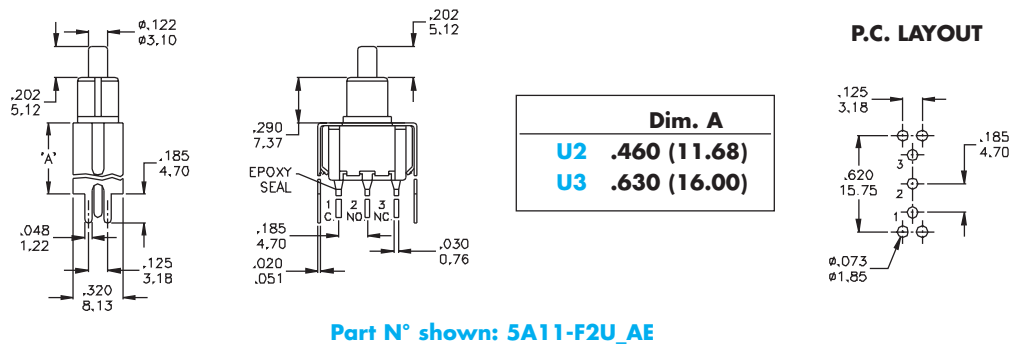



## SERIES 5A

### TERMINATIONS

#### U2 - U3 DPDT

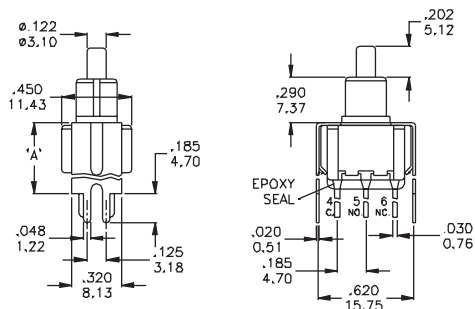

Dim. A	
U2	.460 (11.68)
U3	.630 (16.00)

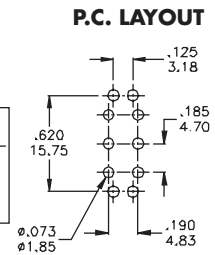

Part N° shown: 5A21-F2U\_AE

#### U4 - U5 SPDT

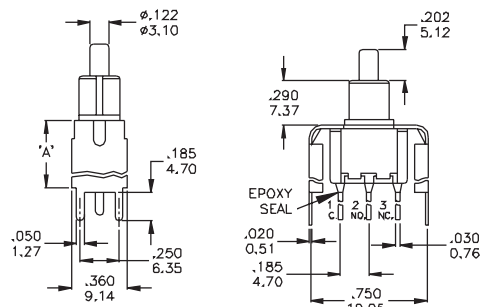

Dim. A	
U4	.460 (11.68)
U5	.630 (16.00)

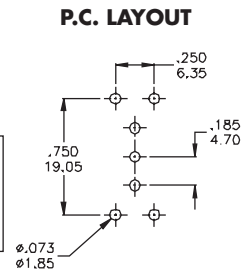

Part N° shown: 5A11-F2U\_AE

#### U4 - U5 DPDT

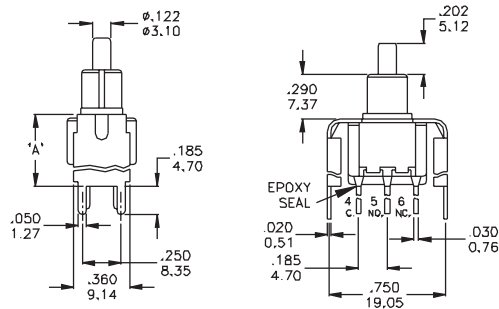

Dim. A	
U4	.460 (11.68)
U5	.630 (16.00)

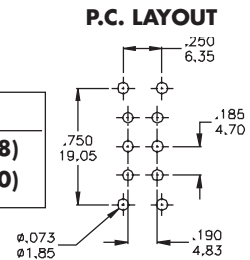

Part N° shown: 5A21-F2U\_AE

### Snap-in termination options

H9S

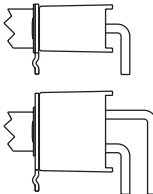
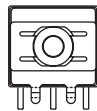

U2S  
U3S



V9S

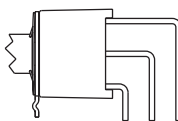
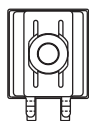

U4S  
U5S



H9S, V9S, U2S, U3S, U4S, U5S have the same P.C layout but are supplied with snap-in bracket to grip onto the PCB

## SERIES 5A

### CAP ACCESSORIES

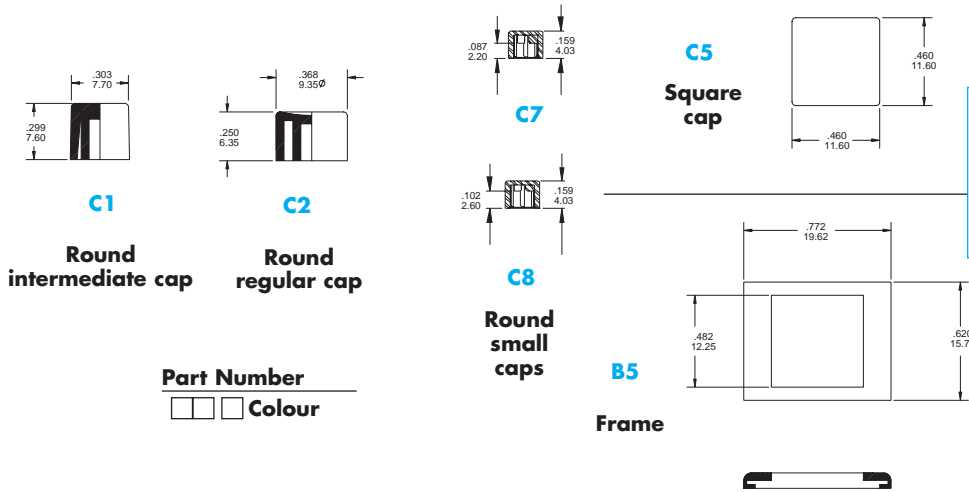

#### CAP - FRAME COLOURS OPTIONS

- |               |          |
|---------------|----------|
| 1 White       | 6Δ Green |
| 2 Black (std) | 7Δ Blue  |
| 3 Red         | 8Δ Brown |
| 4Δ Orange     | 9Δ Gray  |
| 5Δ Yellow     |          |

Part Number  
□ □ Colour

### CONTACT MATERIALS

### CONTACT RATINGS

**S (std)** **Moving Contacts:** coin silver  
**Terminals:** copper alloy, silver plated  
**Rating:** 2 Amps with resistive load @ 250 VAC  
 5 Amps with resistive load @ 125 VAC or 28 VDC

**A** **Moving Contacts:** copper alloy with gold plating over nickel plating  
**Terminals:** copper alloy with gold plating over nickel plating  
**Rating:** 0.4 Volts/Amps max @ 20 Volts max (AC or DC)

**K** Same as **A**, but with pre-tinned terminals

**G** **Moving Contacts:** gold plating over silver  
**End Terminals:** gold plating over silver  
**Center Terminals:** gold plating over copper alloy, silver plated  
**Note:** **G** option used for either "high" (2 Amps @ 250 VAC) or "low" (0.4 Volts/Amps max) contact rating (one exclude the other)

### PACKAGING

### MARKING (on products)

### LABELLING (on packaging)

#### Transparent Trays 15x21x4 cm



Each box contains 100 pcs

The switches are individually marked with the following information:

- Side 1** TRADE MARK  
SERIES AND MODEL  
DATE CODE
- Side 2** RATING  
CONTACTS

Note: Not all information may be available on some products.

The label on each tray gives full information on the products contained.

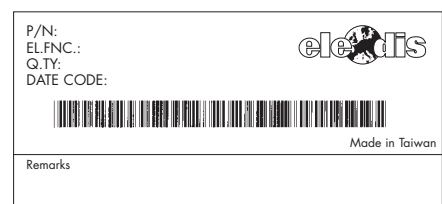

A Bar code indicating Model, Quantity, Date Code enables easy traceability.