

LEDs

Leuchtdioden

Diode Luminescente



Indicator Lights
Signalleuchten
Voyants Lumineux



SLOAN
PRECISION OPTOELECTRONICS

Based LEDs
Gesockelte LEDs
LED à Culot





Request your desired Sloan product catalogue

Fordern Sie Ihre gewünschten Sloan-Produktkataloge an

Demandez les catalogues de produits Sloan de votre choix

LED Module
LED Module
Modules LED

SLOAN
PRECISION OPTOELECTRONICS

LED Profile
LED Profile
Profilé à LED



Emer.-Exit light
Notausgangsleuchten
Eclairage des sorties



SLOAN
PRECISION OPTOELECTRONICS

SLOAN
PRECISION OPTOELECTRONICS

Directory / Inhaltsverzeichnis / Annuaire de contenu

THT LED

∅ 3mm	blue	4
∅ 3mm	green	5
∅ 3mm	red	6
∅ 3mm	yellow	7
∅ 3mm	cold-white	8
∅ 5mm	blue	9
∅ 5mm	green	10
∅ 5mm	red	11
∅ 5mm	yellow	12
∅ 5mm	warm-white	13
∅ 5mm	cold-white	14

THT LED Spacer

∅ 3 + 5mm	length from 3 to 25mm	15
-----------	-----------------------	----

SMD LED

type 0603	blue / green / warm-white / red / white / yellow	16
type 0805	blue / green / warm-white / red / white / yellow	17
type 1206	blue / green / warm-white / red / white / yellow	18
type PLCC2	blue / green / warm-white / red / natural-white / white / yellow	19
type PLCC6	blue / green / warm-white / red / natural-white / white / yellow, RGB	20

Power LED

type PL1	warm-white / white	21
----------	--------------------	----

Precautions for Electro Static Damage ESD



25

THT LED

Ø 3mm blue

- high luminosity
- long lifetime up to 75'000 hours
- high quality for professional application
- RoHS compliant



Part Number	Old Part Number	Peak Wavelength	Intensity (mcd)			Angle (deg)	Voltage (V)		Lens Colour	Type
			min	typ	max		typ	max		
SLO-233B-00003	L3-B41G-WTU	● 462nm	1380	2500	2760	30°	3.2	3.5	waterclear	2
SLO-233B-00004	L3-B71G-WVV	● 470nm	4400	6220	8750	15°	3.2	3.5	waterclear	1

Electro-Optical-Characteristics Ta=25°C, Forward Current: IF Typical = 20mA,

1/10 Duty Cycle, 10ms Pulse Width: up to 110mA, depending on type number.

Storage Temp. -40 ~+100 (°C) Operating Temp. -30 ~+85 (°C)

Detailed data sheets are available on request

Packaging: 500pcs/bulk

Dimensions (mm)

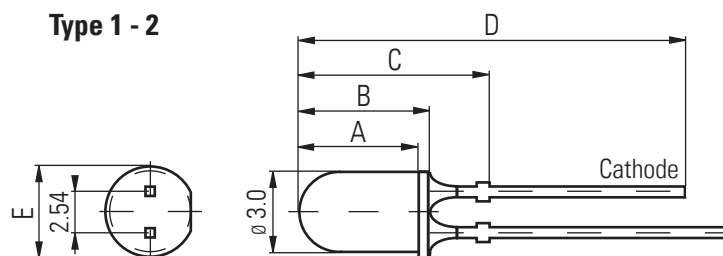

Type	A	B	C	D	E
1	5.0	6.0	11.0	27.5	3.8
2	4.4	5.4	10.4	26.9	3.8

1. All dimensions are in millimetres
2. Tolerance is ±0.25mm unless otherwise specified
3. Specifications are subject to change without notice

THT LED

Ø 3mm green

- high luminosity
- long lifetime up to 75'000 hours
- high quality for professional application
- RoHS compliant



Part Number	Old Part Number	Peak Wavelength	Intensity (mcd)			Angle (deg)	Voltage (V)		Lens Colour	Type
			min	typ	max		typ	max		
SLO-233G-00006	L3-G301	● 568nm	22	-	55	50°	2.2	2.6	diffused	4
SLO-233G-00009	L3-G310-1	● 555nm	14	30	-	35°	2.1	2.6	waterclear	3
SLO-233G-00014	L3-G41N-GVW	● 522nm	24640	36100	49500	15°	3.2	3.6	waterclear	1
SLO-233G-00015	L3-G51N-GUV	● 522nm	7400	10800	14800	30°	3.2	3.5	waterclear	2

Electro-Optical-Characteristics Ta=25°C, Forward Current: IF Typical = 20mA,

1/10 Duty Cycle, 10ms Pulse Width: up to 110mA, depending on type number.

Storage Temp. -40 ~+100 (°C) Operating Temp. -30 ~+85 (°C)

Detailed data sheets are available on request

Packaging: 500pcs/bulk

Dimensions (mm)

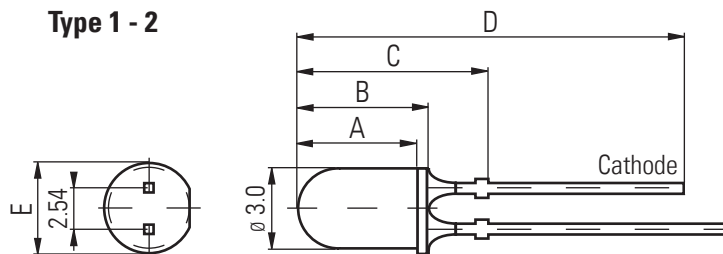

Type	A	B	C	D	E
1	5.0	6.0	11.0	27.5	3.8
2	4.4	5.4	10.4	26.9	3.8
3	4.0	4.7	NA	32.0	3.8
4	4.5	5.3	NA	30.7	3.8

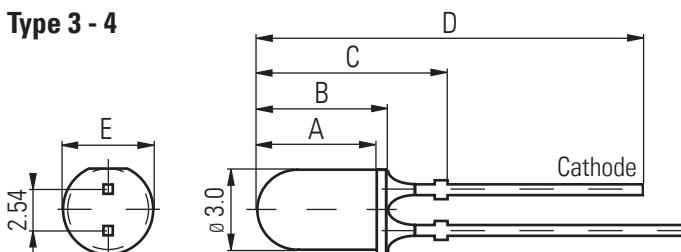

1. All dimensions are in millimetres
2. Tolerance is ±0.25mm unless otherwise specified
3. Specifications are subject to change without notice

THT LED

Ø 3mm red

- high luminosity
- long lifetime up to 75'000 hours
- high quality for professional application
- RoHS compliant



Part Number	Old Part Number	Peak Wavelength	Intensity (mcd)			Angle (deg)	Voltage (V)		Lens Colour	Type
			min	typ	max		typ	max		
SLO-233R-00004	L3-R30U	● 635nm	2800	5500	-	40°	2.25	2.6	waterclear	2
SLO-233R-00005	L3-R301	● 700nm	-	8	-	35°	2.20	2.6	diffused	4
SLO-233R-00010	L3-R310-1	● 660nm	45	100	-	35°	1.80	2.2	waterclear	3
SLO-233R-00012	L3-R32U	● 638nm	1000	1900	-	35°	2.25	2.6	waterclear	1
SLO-233R-00016	L3-R41Q	● 640nm	1500	2500	4000	24°	1.90	2.4	waterclear	1

Electro-Optical-Characteristics Ta=25°C, Forward Current: IF Typical = 20mA,

1/10 Duty Cycle, 10ms Pulse Width: up to 110mA, depending on type number.

Storage Temp. -40 ~+100 (°C) Operating Temp. -30 ~+85 (°C)

Detailed data sheets are available on request

Packaging: 500pcs/bulk

Dimensions (mm)

Type 1 - 4

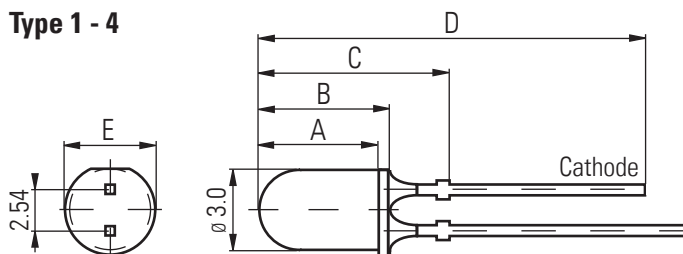

Type	A	B	C	D	E
1	4.3	5.3	NA	29.7	3.9
2	3.4	4.4	NA	28.8	3.1
3	4.0	4.7	NA	32.0	3.8
4	4.5	5.3	NA	30.7	3.8

1. All dimensions are in millimetres

2. Tolerance is ±0.25mm unless otherwise specified

3. Specifications are subject to change without notice

THT LED

Ø 3mm yellow

- high luminosity
- long lifetime up to 75'000 hours
- high quality for professional application
- RoHS compliant



Part Number	Old Part Number	Peak Wavelength	Intensity (mcd)			Angle (deg)	Voltage (V)		Lens Colour	Type
			min	typ	max		typ	max		
SLO-233Y-00003	L3-Y30U	● 592nm	600	1200	-	40°	2.00	2.4	waterclear	2
SLO-233Y-00005	L3-Y301	● 585nm	-	30	-	35°	2.10	2.6	diffused	4
SLO-233Y-00008	L3-Y310-1	● 580nm	40	60	-	23°	2.20	2.8	waterclear	3
SLO-233Y-00009	L3-Y32U	● 592nm	1100	2200	3080	35°	2.25	2.6	waterclear	1
SLO-233Y-00011	L3-Y33U	● 592nm	2100	4200	-	14°	2.25	2.6	waterclear	1
SLO-233Y-00012	L3-Y41Q	● 597nm	1000	2500	4000	24°	2.00	2.6	waterclear	1

Electro-Optical-Characteristics Ta=25°C, Forward Current: IF Typical = 20mA,

1/10 Duty Cycle, 10ms Pulse Width: up to 110mA, depending on type number.

Storage Temp. -40 ~+100 (°C) Operating Temp. -30 ~+85 (°C)

Detailed data sheets are available on request

Packaging: 500pcs/bulk

Dimensions (mm)

Type 1 - 4

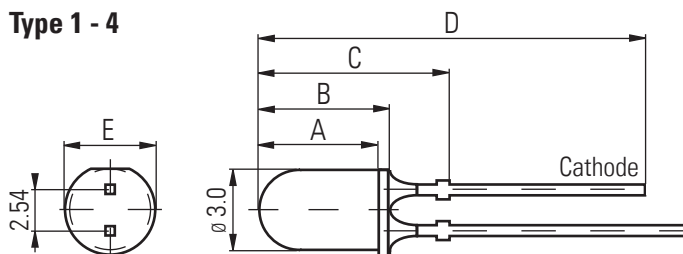

Type	A	B	C	D	E
1	4.3	5.3	NA	29.7	3.9
2	3.4	4.4	NA	28.8	3.1
3	4.0	4.7	NA	32.0	3.8
4	4.5	5.3	NA	30.7	3.8

1. All dimensions are in millimetres

2. Tolerance is ±0.25mm unless otherwise specified

3. Specifications are subject to change without notice

THT LED

Ø 3mm cold-white

- high luminosity
- long lifetime up to 75'000 hours
- high quality for professional application
- RoHS compliant



Part Number	Old Part Number	Colour Temp. (°K)	Intensity (mcd)			Angle (deg)	Voltage (V)		Lens Colour	Type
			min	typ	max		typ	max		
SLO-233W-00001	L3-W32N-BVW	☉ 5500-9000	2520	3400	5040	60°	3.2	3.5	diffused	2
SLO-233W-00002	L3-W36N-BVW	☉ 5500-9000	4610	6200	9220	50°	3.2	3.5	waterclear	2
SLO-233W-00004	L3-W37N-BVW	☉ 5500-9000	9480	12900	18960	20°	3.2	3.5	waterclear	1

Electro-Optical-Characteristics Ta=25°C, Forward Current: IF Typical = 20mA,

1/10 Duty Cycle, 10ms Pulse Width: up to 110mA, depending on type number.

Storage Temp. -40 ~+100 (°C) Operating Temp. -30 ~+85 (°C)

Detailed data sheets are available on request

Packaging: 500pcs/bulk

Dimensions (mm)

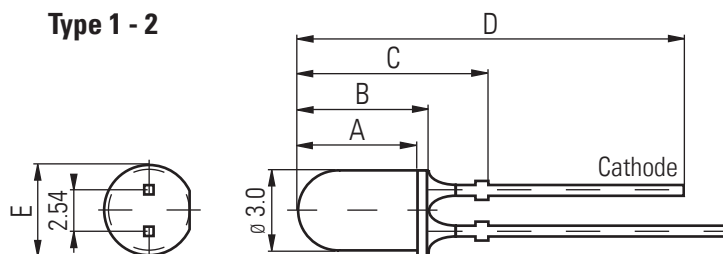

Type	A	B	C	D	E
1	5.0	6.0	11.0	27.5	3.8
2	4.4	5.4	10.4	26.9	3.8

1. All dimensions are in millimetres
2. Tolerance is ± 0.25 mm unless otherwise specified
3. Specifications are subject to change without notice

THT LED

Ø 5mm blue

- high luminosity
- long lifetime up to 75'000 hours
- high quality for professional application
- RoHS compliant



Part Number	Old Part Number	Peak Wavelength	Intensity (mcd)			Angle (deg)	Voltage (V)		Lens Colour	Type
			min	typ	max		typ	max		
SLO-234B-00005	L5-B21G-WVV	● 475nm	3010	4700	6020	30°	3.2	3.5	waterclear	2
SLO-234B-00007	L5-B5SC	● 480nm	1000	2500	4000	30°	3.5	3.8	waterclear	3
SLO-234B-00010	L5-B91G-WUV	● 465nm	4880	9300	13950	15°	3.2	3.5	waterclear	1

Electro-Optical-Characteristics Ta=25°C, Forward Current: IF Typical = 20mA,

1/10 Duty Cycle, 10ms Pulse Width: up to 110mA, depending on type number.

Storage Temp. -40 ~+100 (°C) Operating Temp. -30 ~+85 (°C)

Detailed data sheets are available on request

Packaging: 500pcs/bulk

Dimensions (mm)

Type 1 - 3

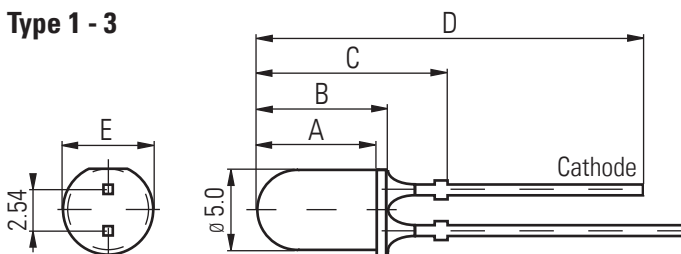

Type	A	B	C	D	E
1	7.6	8.6	12.4	28.9	5.6
2	7.3	8.3	12.1	28.6	5.6
3	7.6	8.6	NA	34.1	5.8

1. All dimensions are in millimetres
2. Tolerance is ±0.25mm unless otherwise specified
3. Specifications are subject to change without notice

THT LED

Ø 5mm green

- high luminosity
- long lifetime up to 75'000 hours
- high quality for professional application
- RoHS compliant



Part Number	Old Part Number	Peak Wavelength	Intensity (mcd)			Angle (deg)	Voltage (V)		Lens Colour	Type
			min	typ	max		typ	max		
SLO-234G-00009	L5-G501	● 574nm	80	250	-	44°	2.4	2.8	diffused	4
SLO-234G-00018	L5-G61N-GVW	● 524nm	10500	16000	21000	30°	3.2	3.5	waterclear	2
SLO-234G-00021	L5-G71N-GUV	● 523nm	3320	6500	9200	45°	3.2	3.5	waterclear	3
SLO-234G-00024	L5-G81N-GUV	● 525nm	21650	37700	43300	15°	3.2	3.5	waterclear	1

Electro-Optical-Characteristics Ta=25°C, Forward Current: IF Typical = 20mA,

1/10 Duty Cycle, 10ms Pulse Width: up to 110mA, depending on type number.

Storage Temp. -40 ~+100 (°C) Operating Temp. -30 ~+85 (°C)

Detailed data sheets are available on request

Packaging: 500pcs/bulk

Dimensions (mm)

Type 1 - 6

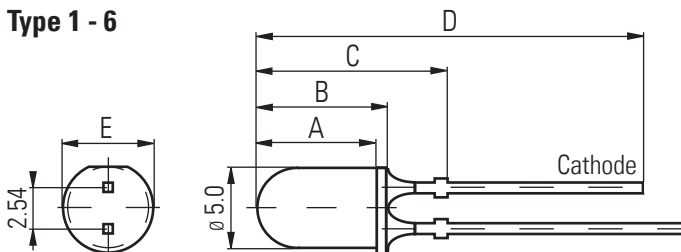

Type	A	B	C	D	E
1	7.6	8.6	12.4	28.9	5.6
2	7.3	8.3	12.1	28.6	5.6
3	6.6	7.6	11.3	27.8	5.6
4	7.7	8.7	NA	31.2	5.9
5	7.9	8.9	13.2	29.7	5.6
6	7.1	8.3	12.1	28.6	5.6

1. All dimensions are in millimetres

2. Tolerance is ±0.25mm unless otherwise specified

3. Specifications are subject to change without notice

THT LED

Ø 5mm red

- high luminosity
- long lifetime up to 75'000 hours
- high quality for professional application
- RoHS compliant



Part Number	Old Part Number	Peak Wavelength	Intensity (mcd)			Angle (deg)	Voltage (V)		Lens Colour	Type
			min	typ	max		typ	max		
SLO-234R-00006	L5-R50U	● 627nm	2500	3200	5500	30°	2.20	2.5	waterclear	2
SLO-234R-00012	L5-R52U	● 620nm	4200	-	7200	30°	2.10	2.4	waterclear	2
SLO-234R-00014	L5-R521	● 635nm	65	80	-	22°	2.00	2.6	diffused	3
SLO-234R-00015	L5-R54U	● 635nm	12000	-	27300	15°	2.10	2.4	waterclear	2
SLO-234R-00016	L5-R55N-RSTU	● 635nm	3400	5000	9600	30°	2.10	2.5	waterclear	4
SLO-234R-00019	L5-R81Q-2	● 660nm	1000	-	4000	22°	1.80	2.4	waterclear	5
SLO-234R-00021	L5-R91H	● 621nm	9300	-	27000	8°	1.94	2.4	waterclear	1

Electro-Optical-Characteristics Ta=25°C, Forward Current: IF Typical = 20mA,

1/10 Duty Cycle, 10ms Pulse Width: up to 110mA, depending on type number.

Storage Temp. -40 ~+100 (°C) Operating Temp. -30 ~+85 (°C)

Detailed data sheets are available on request

Packaging: 500pcs/bulk

Dimensions (mm)

Type 1 - 4

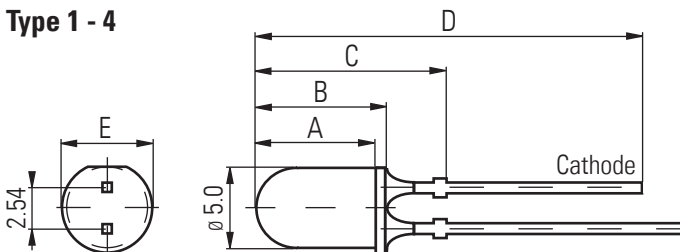

Type	A	B	C	D	E
1	7.6	8.7	NA	31.6	5.8
2	7.6	8.6	NA	33.0	5.7
3	7.6	8.6	NA	34.0	5.7
4	7.1	8.3	12.1	28.6	5.6
5	7.6	8.6	NA	25.5	5.7

1. All dimensions are in millimetres

2. Tolerance is ±0.25mm unless otherwise specified

3. Specifications are subject to change without notice

THT LED

Ø 5mm yellow

- high luminosity
- long lifetime up to 75'000 hours
- high quality for professional application
- RoHS compliant



Part Number	Old Part Number	Peak Wavelength	Intensity (mcd)			Angle (deg)	Voltage (V)		Lens Colour	Type
			min	typ	max		typ	max		
SLO-234Y-00005	L5-Y50U	● 591nm	3000	5500	-	40°	2.10	2.5	waterclear	1
SLO-234Y-00007	L5-Y501	● 591nm	200	500	-	40°	1.90	2.4	diffused	4
SLO-234Y-00010	L5-Y52U	● 592nm	1200	3000	4200	30°	2.00	2.5	waterclear	2
SLO-234Y-00012	L5-Y54U	● 593nm	12000	-	27300	15°	2.10	2.4	waterclear	3
SLO-234Y-00013	L5-Y71Q-2	● 592nm	1000	3000	4000	18°	1.80	2.5	waterclear	2
SLO-234Y-00015	L5-Y91H	● 592nm	7200	-	21000	8°	2.02	2.4	waterclear	1

Electro-Optical-Characteristics Ta=25°C, Forward Current: IF Typical = 20mA,

1/10 Duty Cycle, 10ms Pulse Width: up to 110mA, depending on type number.

Storage Temp. -40 ~+100 (°C) Operating Temp. -30 ~+85 (°C)

Detailed data sheets are available on request

Packaging: 500pcs/bulk

Dimensions (mm)

Type 1 - 4

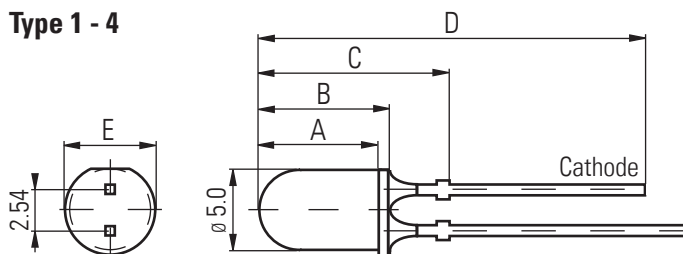

Type	A	B	C	D	E
1	7.7	8.7	NA	31.2	5.9
2	7.6	8.6	NA	33.0	5.7
3	7.6	8.6	NA	34.0	5.7
4	7.7	8.7	NA	36.7	5.8

1. All dimensions are in millimetres

2. Tolerance is ±0.25mm unless otherwise specified

3. Specifications are subject to change without notice

THT LED

Ø 5mm warm-white

- high luminosity
- long lifetime up to 75'000 hours
- high quality for professional application
- RoHS compliant



Part Number	Old Part Number	Colour Temp. (°K)	Intensity (mcd)			Angle (deg)	Voltage (V)		Lens Colour	Type
			min	typ	max		typ	max		
SLO-234N-00001	L5-N52N-FTU	☉ 2500-3500	3000	4700	6000	50°	3.2	3.5	waterclear	2
SLO-234N-00003	L5-N55N-FUV	☉ 2500-3500	15500	22000	31000	15°	3.2	3.5	waterclear	1

Electro-Optical-Characteristics Ta=25°C, Forward Current: IF Typical = 20mA,

1/10 Duty Cycle, 10ms Pulse Width: up to 110mA, depending on type number.

Storage Temp. -40 ~+100 (°C) Operating Temp. -30 ~+85 (°C)

Detailed data sheets are available on request

Packaging: 500pcs/bulk

Dimensions (mm)

Type 1 - 2

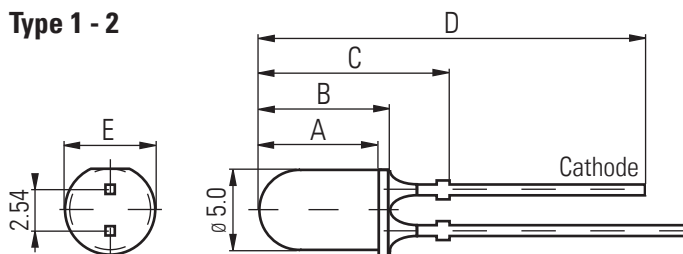

Type	A	B	C	D	E
1	7.6	8.6	12.4	28.9	5.6
2	7.3	8.3	12.1	28.6	5.6

THT LED

Ø 5mm cold-white

- high luminosity
- long lifetime up to 75'000 hours
- high quality for professional application
- RoHS compliant



Part Number	Old Part Number	Colour Temp. (°K)	Intensity (mcd)			Angle (deg)	Voltage (V)		Lens Colour	Type
			min	typ	max		typ	max		
SLO-234W-00001	L5-W50N-BVW	☉ 5500-9000	1610	2380	3220	65°	3.2	3.5	diffused	2
SLO-234W-00002	L5-W53N-BVW	☉ 5500-9000	5200	6150	10400	45°	3.2	3.5	waterclear	2
SLO-234W-00006	L5-W55N-BVW	☉ 5500-9000	22000	27000	44000	20°	3.2	3.5	waterclear	1

Electro-Optical-Characteristics Ta=25°C, Forward Current: IF Typical = 20mA,

1/10 Duty Cycle, 10ms Pulse Width: up to 110mA, depending on type number.

Storage Temp. -40 ~+100 (°C) Operating Temp. -30 ~+85 (°C)

Detailed data sheets are available on request

Packaging: 500pcs/bulk

Dimensions (mm)

Type 1 - 2

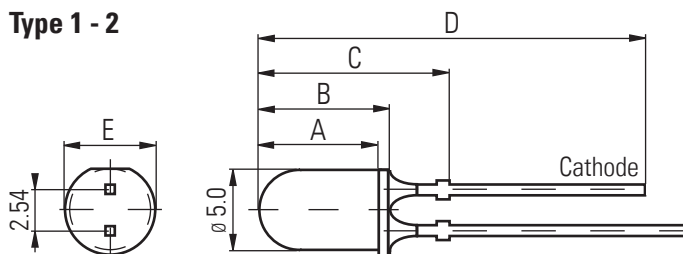

Type	A	B	C	D	E
1	7.6	8.6	12.4	28.9	5.6
2	7.3	8.3	12.1	28.6	5.6

THT LED spacer

for Ø 3 + 5mm

- temperature resistance of approx. 140°C
- material: polycarbonat (PC) and glass fibre (GF)
- colour: grey
- RoHS compliant

This product contains the substance of very high concern
(REACH Regulation (EC) No 1907/2006 Art. 59):

Potassium Perfluorobutanesulfonate - CAS No. 29420-49-3 - EC No. 249-616-3



3mm LED Spacers

Part No.	Length (mm)
546.71.03	3.0
546.71.04	4.0
546.71.05	5.0
546.71.06	6.0
546.71.07	7.0
546.71.08	8.0
546.71.09	9.0
546.71.10	10.0
546.71.11	11.0
546.71.12	12.0
546.71.13	13.0
546.71.14	14.0
546.71.15	15.0
546.71.16	16.0
546.71.17	17.0
546.71.18	18.0
546.71.19	19.0
546.71.20	20.0
546.71.21	21.0
546.71.22	22.0
546.71.23	23.0
546.71.24	24.0
546.71.25	25.0

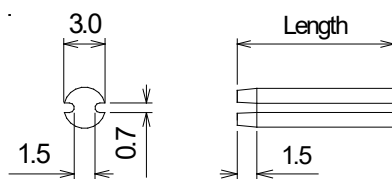

5mm LED Spacers

Part No.	Length (mm)
325.71.02	2.0
325.71.03	3.0
325.71.04	4.0
325.71.05	5.0
325.71.06	6.0
325.71.07	7.0
325.71.08	8.0
325.71.09	9.0
325.71.10	10.0
325.71.11	11.0
325.71.12	12.0
325.71.13	13.0
325.71.14	14.0
325.71.15	15.0
325.71.16	16.0
325.71.17	17.0
325.71.18	18.0
325.71.19	19.0
325.71.20	20.0
325.71.21	21.0
325.71.22	22.0
325.71.23	23.0
325.71.24	24.0
325.71.25	25.0

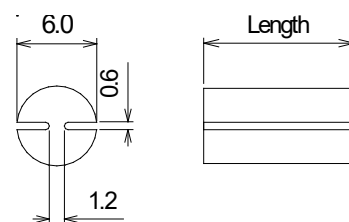





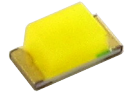

1. All dimensions are in millimetres
2. Tolerance is ± 0.10 mm unless otherwise specified
3. Specifications are subject to change without notice

SMD LED

type 0603

- top LED
- dimension 1.6x0.8x0.68mm
- viewing angle: 120°
- RoHS compliant



Part Number	Old Part Number	Peak Wavelength	Intensity (mcd)			Angle (deg)	Voltage (V)		Lens Colour
			min	typ	max		typ	max	
SLO-230B-00006	SMD-B0603-02	 460nm	70	100	-	130°	2.7	3.3	waterclear
SLO-230G-00007	SMD-G0603-02	 510nm	600	800	-	130°	2.6	3.3	waterclear
SLO-230R-00006	SMD-R0603-02	 630nm	50	70	-	130°	1.7	2.3	waterclear
SLO-230Y-00004	SMD-Y0603-02	 588nm	90	120	-	130°	1.8	2.0	waterclear
SLO-230N-00005	SMD-N0603-02	 3000-3500°K	460	600	-	120°	2.7	3.3	diffused
SLO-230W-00007	SMD-W0603-02	 6000-7000°K	460	600	-	130°	2.7	3.3	diffused

Electro-Optical-Characteristics Ta=25°C, Forward Current: IF Typical = 20mA,

1/10 Duty Cycle, 10ms Pulse Width: up to 160mA, depending on colour.

Storage Temp. -40 ~+100 (°C) Operating Temp. -40 ~+85 (°C)

Detailed data sheets are available on request

Packaging: 4000pcs/reel

Dimensions (mm)

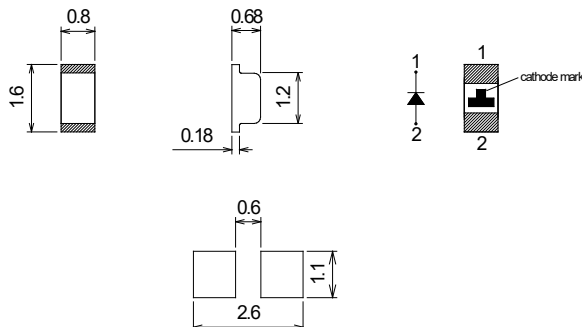







1. All dimensions are in millimetres
2. Tolerance is ± 0.25 mm unless otherwise specified
3. Specifications are subject to change without notice

SMD LED

type 0805

- top LED
- dimension 2.0x1.25x0.68mm
- viewing angle: 120°
- RoHS compliant



Part Number	Old Part Number	Peak Wavelength	Intensity (mcd)			Angle (deg)	Voltage (V)		Lens Colour
			min	typ	max		typ	max	
SLO-230B-00007	SMD-B0805-02	 460nm	160	220	-	140°	2.8	3.4	waterclear
SLO-230G-00008	SMD-G0805-02	 525nm	355	550	-	120°	3.2	-	waterclear
SLO-230R-00007	SMD-R0805-02	 630nm	70	110	-	120°	1.9	-	waterclear
SLO-230Y-00005	SMD-Y0805-02	 595nm	160	230	-	120°	2.0	-	waterclear
SLO-230N-00006	SMD-N0805-02	 3000-3500°K	600	800	-	120°	3.2	-	diffused
SLO-230W-00008	SMD-W0805-02	 6000-7000°K	600	800	-	120°	3.2	-	diffused

Electro-Optical-Characteristics Ta=25°C, Forward Current: IF Typical = 20mA,

1/10 Duty Cycle, 10ms Pulse Width: up to 180mA, depending on colour.

Storage Temp. -40 ~+100 (°C) Operating Temp. -40 ~+85 (°C)

Detailed data sheets are available on request

Packaging: 3000pcs/reel

Dimensions (mm)

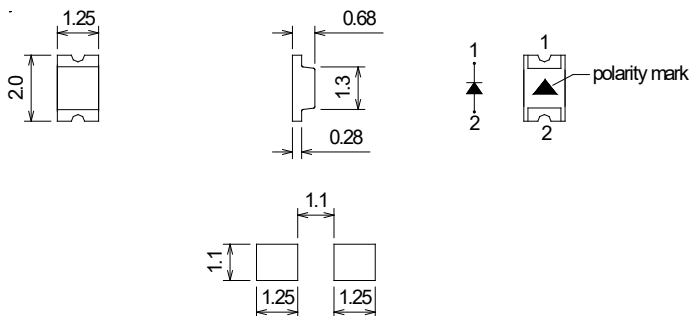





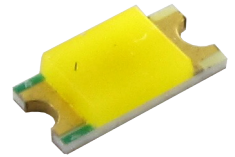

1. All dimensions are in millimetres
2. Tolerance is ± 0.25 mm unless otherwise specified
3. Specifications are subject to change without notice

SMD LED

type 1206

- top LED
- dimension 3.2x1.6x0.68mm
- viewing angle: 120°
- RoHS compliant



Part Number	Old Part Number	Dominate Wavelength	Intensity (mcd)			Angle (deg)	Voltage (V)		Lens Colour
			min	typ	max		typ	max	
SLO-230B-00008	SMD-B1206-02	 460nm	160	210	-	140°	2.8	3.4	waterclear
SLO-230G-00009	SMD-G1206-02	 518nm	600	800	-	140°	2.6	3.4	waterclear
SLO-230R-00008	SMD-R1206-02	 628nm	70	100	-	120°	1.9	-	waterclear
SLO-230Y-00006	SMD-Y1206-02	 588nm	120	210	-	120°	1.8	2.4	waterclear
SLO-230N-00007	SMD-N1206-02	 3000-3500°K	1015	-	1715	120°	3.0	-	diffused
SLO-230W-00009	SMD-W1206-02	 6000-7000°K	1000	1300	-	140°	2.8	3.4	diffused

Electro-Optical-Characteristics Ta=25°C, Forward Current: IF Typical = 20mA,

1/10 Duty Cycle, 10ms Pulse Width: up to 180mA, depending on colour.

Storage Temp. -40 ~+100 (°C) Operating Temp. -40 ~+85 (°C)

Detailed data sheets are available on request

Packaging: 3000pcs/reel

Dimensions (mm)

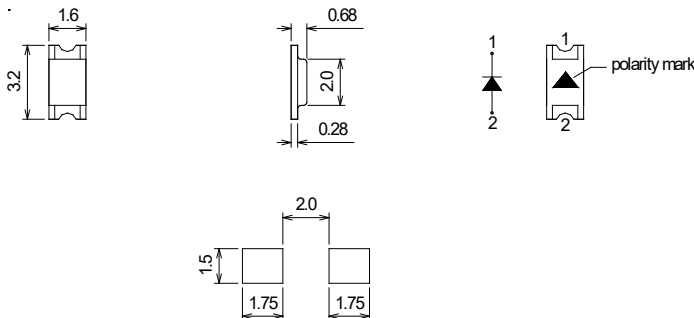







1. All dimensions are in millimetres
2. Tolerance is ± 0.25 mm unless otherwise specified
3. Specifications are subject to change without notice

SMD LED

type PLCC2

- top LED
- dimension 2.8x3.2x1.9mm
- viewing angle: 120°
- RoHS compliant



Part Number	Old Part Number	Peak Wavelength	Intensity (mcd)			Angle (deg)	Voltage (V)		Lens Colour	Type
			min	typ	max		typ	max		
SLO-230B-00011	SMD-BPLCC-02	 470nm	220	320	-	120°	3.2	-	waterclear	1
SLO-230G-00002	SMD-GPLCC-04	 515nm	1000	1600	-	120°	2.8	3.4	waterclear	1
SLO-230R-00009	SMD-RPLCC-04	 630nm	600	780	-	120°	1.8	2.4	waterclear	1
SLO-230Y-00001	SMD-YPLCC-02	 593nm	160	210	-	120°	1.8	2.4	waterclear	1
SLO-230N-00001	SMD-NPLCC-02	 2800-3100°K	600	-	820	120°	3.2	-	diffused	2
SLO-230S-00001	SMD-SPLCC-02	 3800-5000°K	2100	2200	2300	120°	2.8	3.4	diffused	2
SLO-230W-00002	SMD-WPLCC-02	 5500-7000°K	1000	1300	-	120°	3.0	3.2	diffused	2

Electro-Optical-Characteristics Ta=25°C, Forward Current: IF Typical = 20mA,

1/10 Duty Cycle, 10ms Pulse Width: up to 180mA, depending on colour.

Storage Temp. -40 ~+100 (°C) Operating Temp. -40 ~+85 (°C)

Detailed data sheets are available on request

Packaging: 2000pcs/reel

Dimensions (mm)

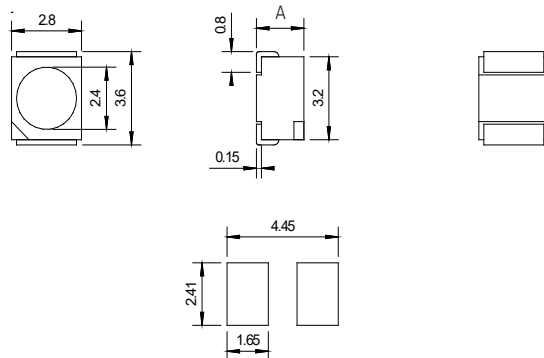

Type	A
1	1.9
2	1.4











1. All dimensions are in millimetres
2. Tolerance is ± 0.25 mm unless otherwise specified
3. Specifications are subject to change without notice

SMD LED

type PLCC6

- top LED
- dimension 5.0 x 5.0 x 1.5mm
- viewing angle: 120°
- RoHS compliant



Part Number	Old Part Number	Peak Wavelength	Intensity (mcd)			Angle (deg)	Voltage (V)		Lens Colour
			min	typ	max		typ	max	
SLO-230B-00010	SMD-BPLCC6-02	 465nm	780	1000	-	120°	2.8	3.2	waterclear
SLO-230G-00005	SMD-GPLCC6-02	 520nm	1800	-	3500	120°	2.8	3.2	waterclear
SLO-230R-00004	SMD-RPLCC6-02	 630nm	1300	1700	-	120°	1.8	2.4	waterclear
SLO-230Y-00003	SMD-YPLCC6-02	 586nm	460	660	-	120°	2.0	-	waterclear
SLO-230N-00004	SMD-NPLCC6-02	 2800-3100°K	3370	6370	6370	120°	3.0	3.2	diffused
SLO-230S-00002	SMD-SPLCC6-02	 3800-5000°K	5300	-	7600	120°	2.8	3.4	diffused
SLO-230W-00005	SMD-WPLCC6-02	 5500-7000°K	3770	-	6370	120°	3.0	3.2	diffused
SLO-2351-00001	SMD-FPLCC6-02	 630nm	350	460	-	120°	1.8	2.4	waterclear
		 518nm	1000	1300	-	120°	2.8	3.4	
		 462nm	210	270	-	120°	2.8	3.4	

Electro-Optical-Characteristics Ta=25°C, Forward Current: IF Typical = 20mA (x3),

1/10 Duty Cycle, 10ms Pulse Width: up to 180mA, depending on colour.

Storage Temp. -40 ~+100 (°C) Operating Temp. -40 ~+85 (°C)

Detailed data sheets are available on request

Packaging: 1000pcs/reel

Dimensions (mm)

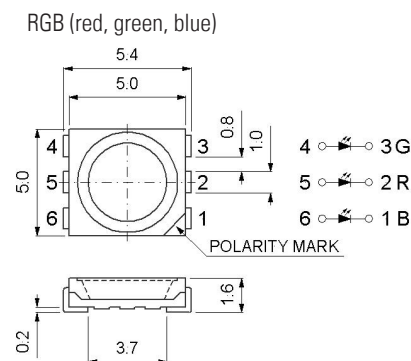
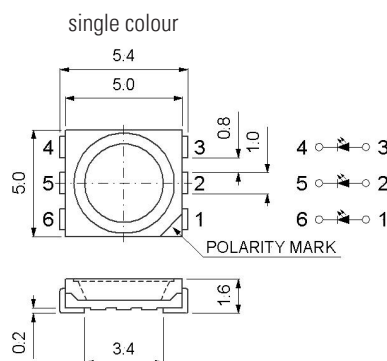

1. All dimensions are in millimetres
2. Tolerance is ± 0.25 mm unless otherwise specified
3. Specifications are subject to change without notice

Power LED

type PL1

- high luminosity
- high quality or professional application
- reflow soldering
- RoHS compliant



Part Number	Old Part Number	Colour Temp. (°K)	Intensity (mcd)			Angle (deg)	Voltage (V)		Lens Colour
			min	typ	max		typ	max	
SLO-231N-00002	PL1-NL11-01	☉ 2700	70	95	100	120°	3.5	4.0	diffused
SLO-231W-00004	PL1-WL11-00	☁ 4500-5500	100	110	120	120°	3.5	4.0	diffused
SLO-231N-00005	PL1-NL11-00	☉ 3000	70	95	100	120°	3.5	4.0	diffused

Electro-Optical-Characteristics Ta=25°C, Forward Current: IF Typical = 350mA,

1/10 Duty Cycle, 10ms Pulse Width: up to 600mA, depending on colour.

Storage Temp. -40 ~+100 (°C) Operating Temp. -40 ~+85 (°C)

Detailed data sheets are available on request

Packaging: 1400pcs/reel

Dimensions (mm)

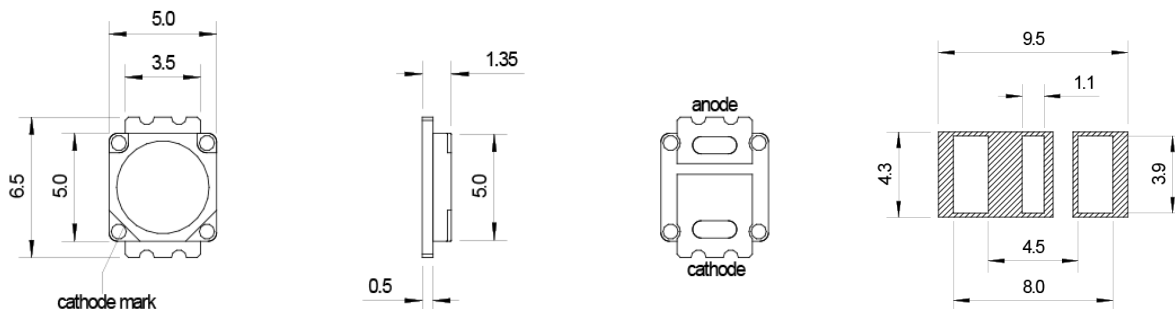

1. All dimensions are in millimetres
2. Tolerance is ± 0.25 mm unless otherwise specified
3. Specifications are subject to change without notice

Precautions for Electro Static Damage ESD

LEDs and LED products are sensitive for static electricity. There are several precautions for proper ESD safe handling.

Handling:

Make sure working persons are trained in ESD safe handling of LEDs and LED products and are always properly grounded when working with LEDs and LED products.

We suggest to always use the following equipment when working with LEDs and LED products:

- Grounded conductive floor mats
- Grounded conductive table mats (with the same potential as the floor)
- Conductive shoes or slippers to be worn by the persons handling the LEDs
- Grounded conductive wrist band to be worn by the persons handling the LEDs
- Anti-electrostatic gloves to handle the LEDs (these will also help to protect the LEDs from contamination with dirt and other substances)
- Grounded working equipment, e.g. soldering irons, calibration equipment and other tools
- Anti-electrostatic clothing to be worn by persons handling the LEDs
- Ionized air blower
- Humidifier (especially in a dry working environment)

Delivery:

The LEDs and LED products have to be transported in a conductive container.

Storage:

The LEDs and LED products have to be stored in a conductive container located on a grounded surface.

Operation:

Prevent LEDs and LED products from electrostatic discharge.

Only use EMC approved power supplies.

Use additional EMC protective electronic components, if your application or environment requires it.

Major application fields:

Automotive/Special vehicles:

Warning lights, emergency indicators, car immobilizing systems, car factory automation.

Blue LED flashers for Police cars, Diplomacy cars, special forces vehicles.

Consumer electronics:

Microwave ovens, toasters, coffee machines, Irons, refrigerators.

Industrial controls / Traffic controls:

Panel indicators, elevators, photo-processing darkroom lights, traffic control, railway track diagram indicators, power stations.

LED clusters for railway use.

Telecommunication:

PCB line indicators, status indicators, portable communication equipment.

Defence:

Tank/tank missiles, combat aircrafts, mine detectors warning lights, submarine engine control, fire coordination systems for tanks.

28 NATO Numbers.

NATO Manufacturer Code S3643.

French Army „GAM T1“ listed.

Aviation:

Commercial and military, cockpit lights, stewardess call systems.

Security:

Safety control panels surveillance, emergency lights.

Medical:

Fault indicators, sealed indicators for surgery equipment,

blood analyser, nurse-call systems, dentist equipment.

We strive to be a Total Quality company that anticipates and responds to our customer's needs, continuously improving our products and processes.



SIBALCO AG

Birmannsgasse 8

CH-4055 Basel

Switzerland

Tel. +41 (0)61 264 10 10

Fax +41 (0)61 264 10 15

info@sibalco.ch

www.sloan.ch